

IRFPE50PbF

HEXFET® Power MOSFET

- Dynamic dv/dt Rating
- Repetitive Avalanche Rated
- Isolated Central Mounting Hole
- Fast Switching
- Ease of Paralleling
- Simple Drive Requirements
- Lead-Free

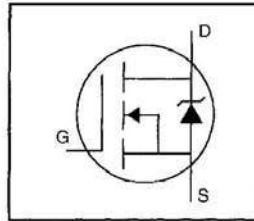

$$V_{DSS} = 800V$$

$$R_{DS(on)} = 1.2\Omega$$

$$I_D = 7.8A$$

Description

Third Generation HEXFETs from International Rectifier provide the designer with the best combination of fast switching, ruggedized device design, low on-resistance and cost-effectiveness.

The TO-247 package is preferred for commercial-industrial applications where higher power levels preclude the use of TO-220 devices. The TO-247 is similar but superior to the earlier TO-218 package because of its isolated mounting hole. It also provides greater creepage distance between pins to meet the requirements of most safety specifications.

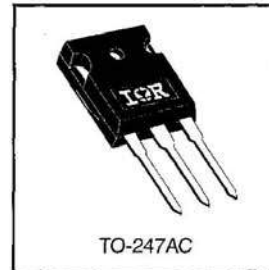

Absolute Maximum Ratings

	Parameter	Max.	Units
$I_D @ T_C = 25^\circ C$	Continuous Drain Current, $V_{GS} @ 10 V$	7.8	A
$I_D @ T_C = 100^\circ C$	Continuous Drain Current, $V_{GS} @ 10 V$	4.9	
I_{DM}	Pulsed Drain Current ①	31	
$P_D @ T_C = 25^\circ C$	Power Dissipation	190	W
	Linear Derating Factor	1.5	W/°C
V_{GS}	Gate-to-Source Voltage	± 20	V
E_{AS}	Single Pulse Avalanche Energy ②	770	mJ
I_{AR}	Avalanche Current ①	7.8	A
E_{AR}	Repetitive Avalanche Energy ①	19	mJ
dv/dt	Peak Diode Recovery dv/dt ③	2.0	V/ns
T_J	Operating Junction and	-55 to +150	°C
T_{STG}	Storage Temperature Range		
	Soldering Temperature, for 10 seconds		
	Mounting Torque, 6-32 or M3 screw	10 lbf·in (1.1 N·m)	

Thermal Resistance

	Parameter	Min.	Typ.	Max.	Units
$R_{\theta JC}$	Junction-to-Case	—	—	0.65	°C/W
$R_{\theta CS}$	Case-to-Sink, Flat, Greased Surface	—	0.24	—	
$R_{\theta JA}$	Junction-to-Ambient	—	—	40	

11/14/03

IRFPE50PbF

International
 Rectifier

Electrical Characteristics @ $T_J = 25^\circ\text{C}$ (unless otherwise specified)

	Parameter	Min.	Typ.	Max.	Units	Test Conditions
$V_{(BR)DSS}$	Drain-to-Source Breakdown Voltage	800	—	—	V	$V_{GS}=0V, I_D=250\mu A$
$\Delta V_{(BR)DSS}/\Delta T_J$	Breakdown Voltage Temp. Coefficient	—	0.98	—	V/ $^\circ\text{C}$	Reference to 25°C , $I_D=1\text{mA}$
$R_{DS(on)}$	Static Drain-to-Source On-Resistance	—	—	1.2	Ω	$V_{GS}=10V, I_D=4.7A$ ③
$V_{GS(th)}$	Gate Threshold Voltage	2.0	—	4.0	V	$V_{DS}=V_{GS}, I_D=250\mu A$
g_{fs}	Forward Transconductance	5.6	—	—	S	$V_{DS}=100V, I_D=4.7A$ ④
I_{DSS}	Drain-to-Source Leakage Current	—	—	100	μA	$V_{DS}=800V, V_{GS}=0V$
		—	—	500		$V_{DS}=640V, V_{GS}=0V, T_J=125^\circ\text{C}$
I_{GSS}	Gate-to-Source Forward Leakage	—	—	100	nA	$V_{GS}=20V$
	Gate-to-Source Reverse Leakage	—	—	-100		$V_{GS}=-20V$
Q_g	Total Gate Charge	—	—	200	nC	$I_D=7.8A$ $V_{DS}=400V$ $V_{GS}=10V$ See Fig. 6 and 13 ④
Q_{gs}	Gate-to-Source Charge	—	—	24		
Q_{gd}	Gate-to-Drain ("Miller") Charge	—	—	110		
$t_{d(on)}$	Turn-On Delay Time	—	19	—	ns	$V_{DD}=400V$ $I_D=7.8A$ $R_G=6.2\Omega$ $R_D=52\Omega$ See Figure 10 ④
t_r	Rise Time	—	38	—		
$t_{d(off)}$	Turn-Off Delay Time	—	120	—		
t_f	Fall Time	—	39	—		
L_D	Internal Drain Inductance	—	5.0	—	nH	Between lead, 6 mm (0.25in.) from package and center of die contact 
L_S	Internal Source Inductance	—	13	—		
C_{iss}	Input Capacitance	—	3100	—	pF	$V_{GS}=0V$ $V_{DS}=25V$ $f=1.0\text{MHz}$ See Figure 5
C_{oss}	Output Capacitance	—	800	—		
C_{rss}	Reverse Transfer Capacitance	—	490	—		

Source-Drain Ratings and Characteristics

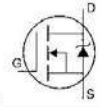
	Parameter	Min.	Typ.	Max.	Units	Test Conditions
I_S	Continuous Source Current (Body Diode)	—	—	7.8	A	MOSFET symbol showing the integral reverse p-n junction diode. 
I_{SM}	Pulsed Source Current (Body Diode) ①	—	—	31		
V_{SD}	Diode Forward Voltage	—	—	1.8	V	$T_J=25^\circ\text{C}, I_S=7.8A, V_{GS}=0V$ ④
t_{rr}	Reverse Recovery Time	—	650	980	ns	$T_J=25^\circ\text{C}, I_F=7.8A$
Q_{rr}	Reverse Recovery Charge	—	3.8	5.7	μC	$di/dt=100A/\mu s$ ④
t_{on}	Forward Turn-On Time	Intrinsic turn-on time is negligible (turn-on is dominated by L_S+L_D)				

Notes:

- ① Repetitive rating; pulse width limited by max. junction temperature (See Figure 11)
- ② $V_{DD}=50V$, starting $T_J=25^\circ\text{C}$, $L=23\text{mH}$
 $R_G=25\Omega$, $I_{AS}=7.8A$ (See Figure 12)
- ③ $I_{SD}\leq 7.8A$, $di/dt\leq 140A/\mu s$, $V_{DD}\leq 600$,
 $T_J\leq 150^\circ\text{C}$
- ④ Pulse width $\leq 300\mu s$; duty cycle $\leq 2\%$.

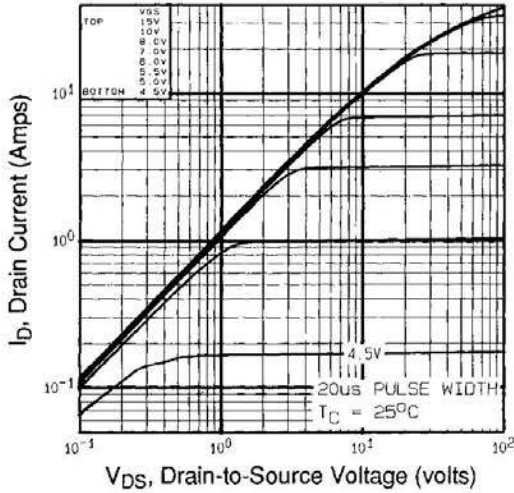

Fig 1. Typical Output Characteristics,
 $T_C = 25^\circ\text{C}$

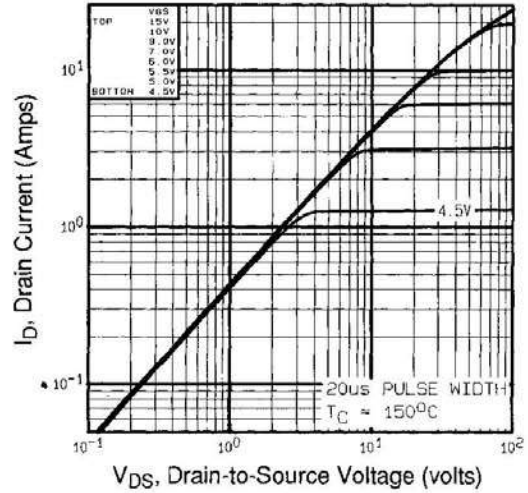

Fig 2. Typical Output Characteristics,
 $T_C = 150^\circ\text{C}$

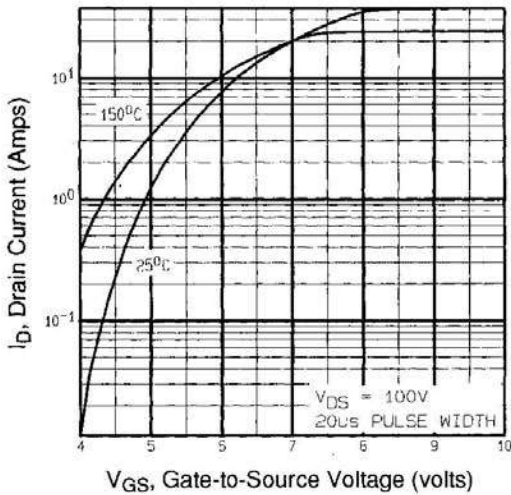

Fig 3. Typical Transfer Characteristics

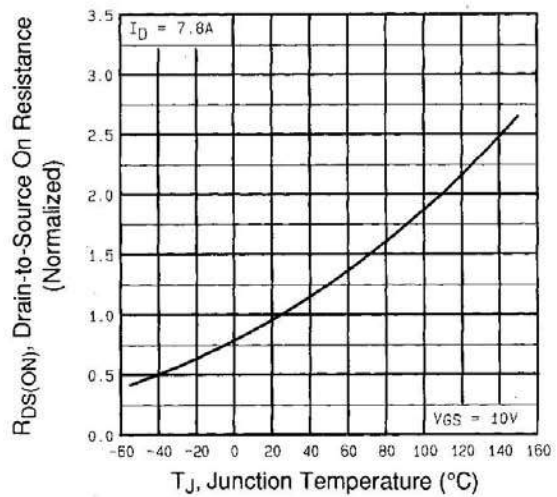

Fig 4. Normalized On-Resistance
Vs. Temperature

IRFPE50PbF

International
IR Rectifier

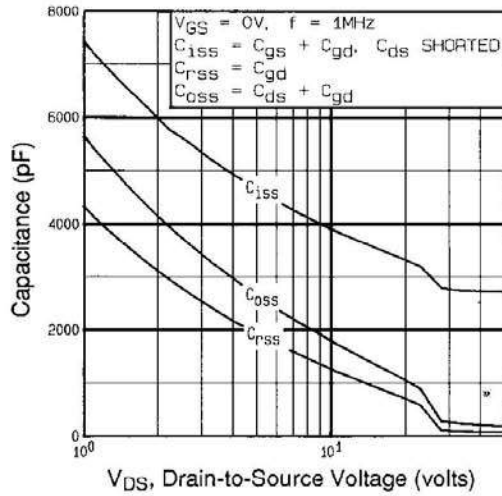

Fig 5. Typical Capacitance Vs. Drain-to-Source Voltage

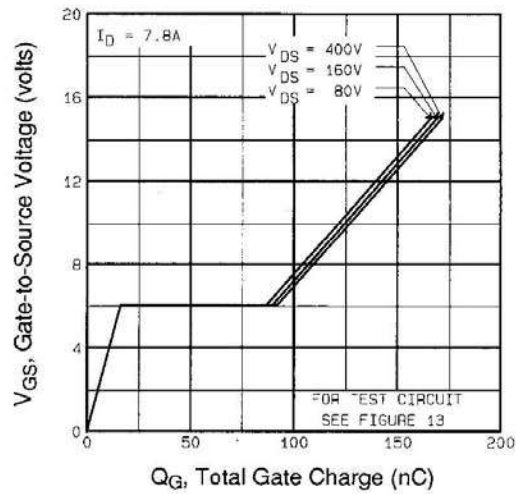

Fig 6. Typical Gate Charge Vs. Gate-to-Source Voltage

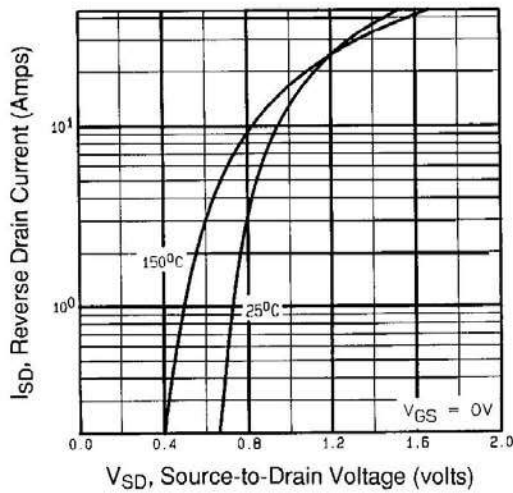

Fig 7. Typical Source-Drain Diode Forward Voltage

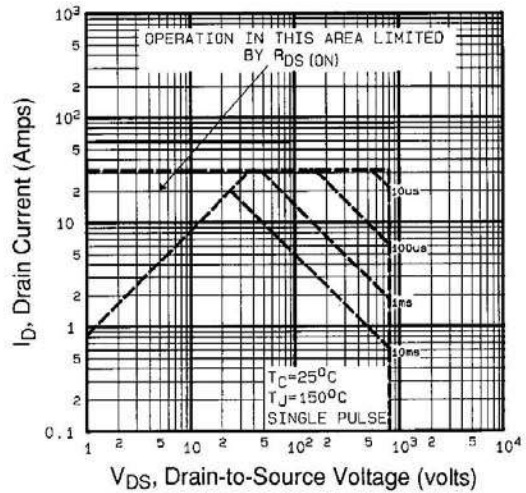

Fig 8. Maximum Safe Operating Area

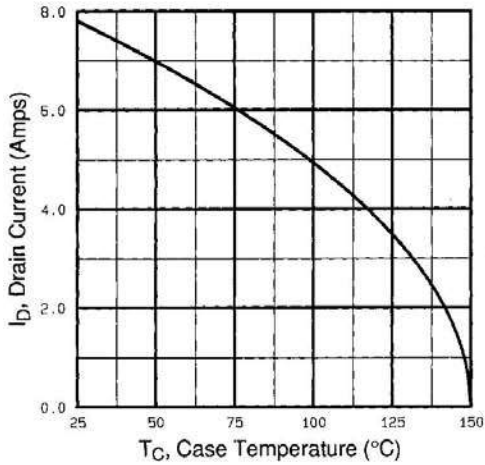

Fig 9. Maximum Drain Current Vs. Case Temperature

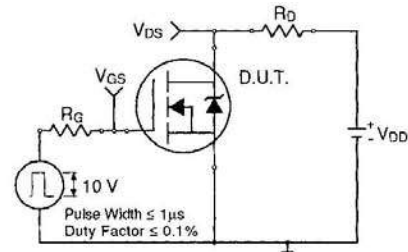

Fig 10a. Switching Time Test Circuit

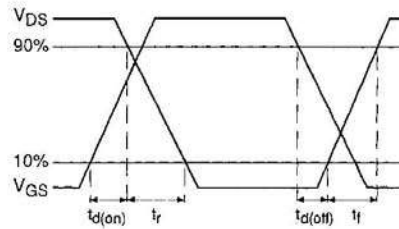

Fig 10b. Switching Time Waveforms

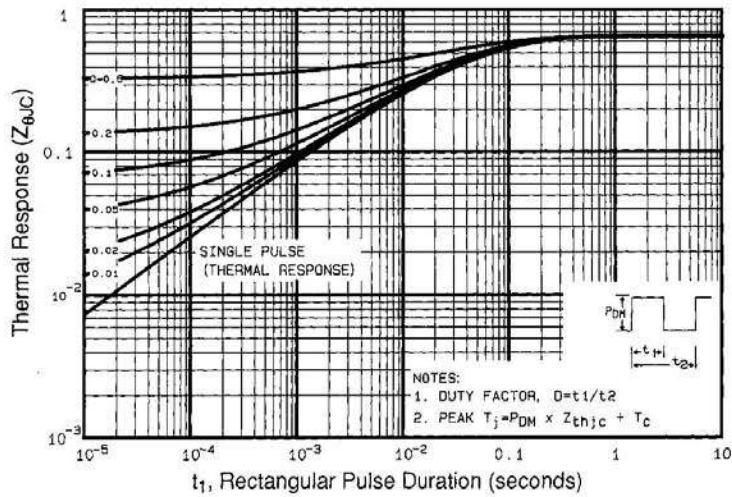

Fig 11. Maximum Effective Transient Thermal Impedance, Junction-to-Case

IRFPE50PbF

International
IR Rectifier

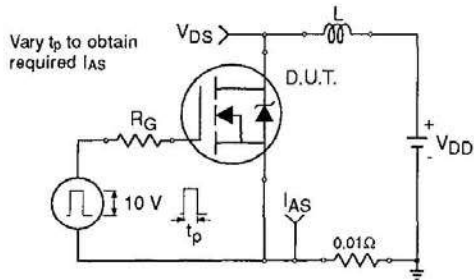

Fig 12a. Unclamped Inductive Test Circuit

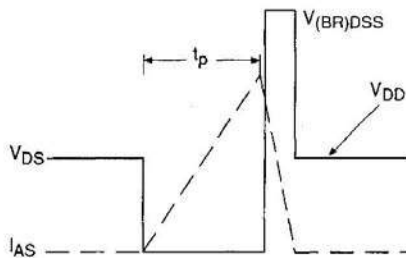

Fig 12b. Unclamped Inductive Waveforms

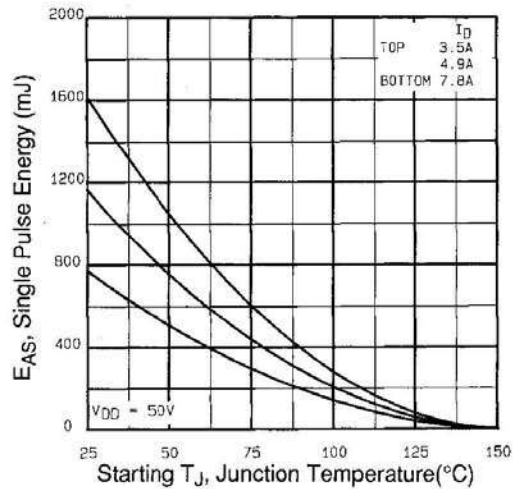

Fig 12c. Maximum Avalanche Energy Vs. Drain Current

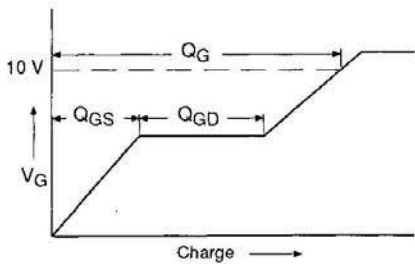

Fig 13a. Basic Gate Charge Waveform

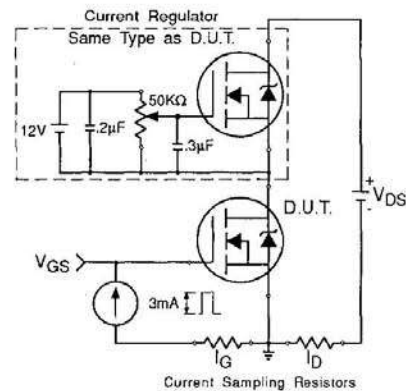

Fig 13b. Gate Charge Test Circuit

Appendix A: Figure 14, Peak Diode Recovery dv/dt Test Circuit – See page 1505

Appendix B: Package Outline Mechanical Drawing – See page 1511

TO-247AC Package Outline

Dimensions are shown in millimeters (inches)

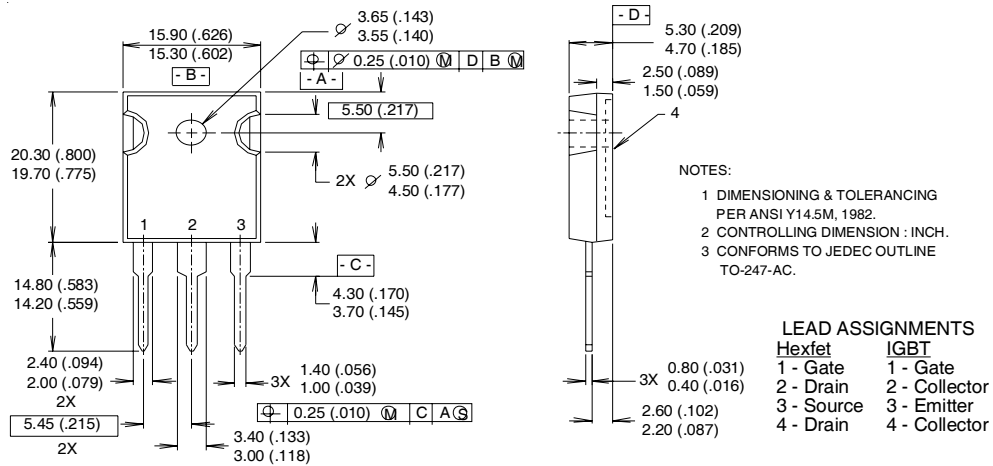

TO-247AC Part Marking Information

EXAMPLE: THIS IS AN IRFPE30
 WITH ASSEMBLY
 LOT CODE 5657
 ASSEMBLED ON VWV 35, 2000
 IN THE ASSEMBLY LINE "H"
Note: "P" in assembly line
 position indicates "Lead-Free"

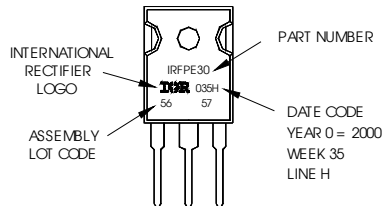

Data and specifications subject to change without notice.



Notice

The products described herein were acquired by Vishay Intertechnology, Inc., as part of its acquisition of International Rectifier's Power Control Systems (PCS) business, which closed in April 2007. Specifications of the products displayed herein are pending review by Vishay and are subject to the terms and conditions shown below.

Specifications of the products displayed herein are subject to change without notice. Vishay Intertechnology, Inc., or anyone on its behalf, assumes no responsibility or liability for any errors or inaccuracies.

Information contained herein is intended to provide a product description only. No license, express or implied, by estoppel or otherwise, to any intellectual property rights is granted by this document. Except as provided in Vishay's terms and conditions of sale for such products, Vishay assumes no liability whatsoever, and disclaims any express or implied warranty, relating to sale and/or use of Vishay products including liability or warranties relating to fitness for a particular purpose, merchantability, or infringement of any patent, copyright, or other intellectual property right.

The products shown herein are not designed for use in medical, life-saving, or life-sustaining applications. Customers using or selling these products for use in such applications do so at their own risk and agree to fully indemnify Vishay for any damages resulting from such improper use or sale.

International Rectifier®, IR®, the IR logo, HEXFET®, HEXSense®, HEXDIP®, DOL®, INTERO®, and POWIRTRAIN® are registered trademarks of International Rectifier Corporation in the U.S. and other countries. All other product names noted herein may be trademarks of their respective owners.